



Universal Oven

UN30

Precise drying, heating, ageing, burn-in and hardening in research, science, industry and quality assurance.



The universally applicable lab oven U is Memmert's classic appliance for temperature control in science, research and material tests in industry. The technologically perfected masterpiece made of high-quality, hygienic, easy-to-clean stainless steel leaves nothing to be desired in terms of ventilation and control technology, overtemperature protection and precisely tuned heating technology.

On this page, you can find all the essential technical data on the universal Memmert lab oven. Our customer relations team will be pleased to help if you want further information. If you should require a customised special solution, please contact our technical specialists at myAtmoSAFE@memmert.com.

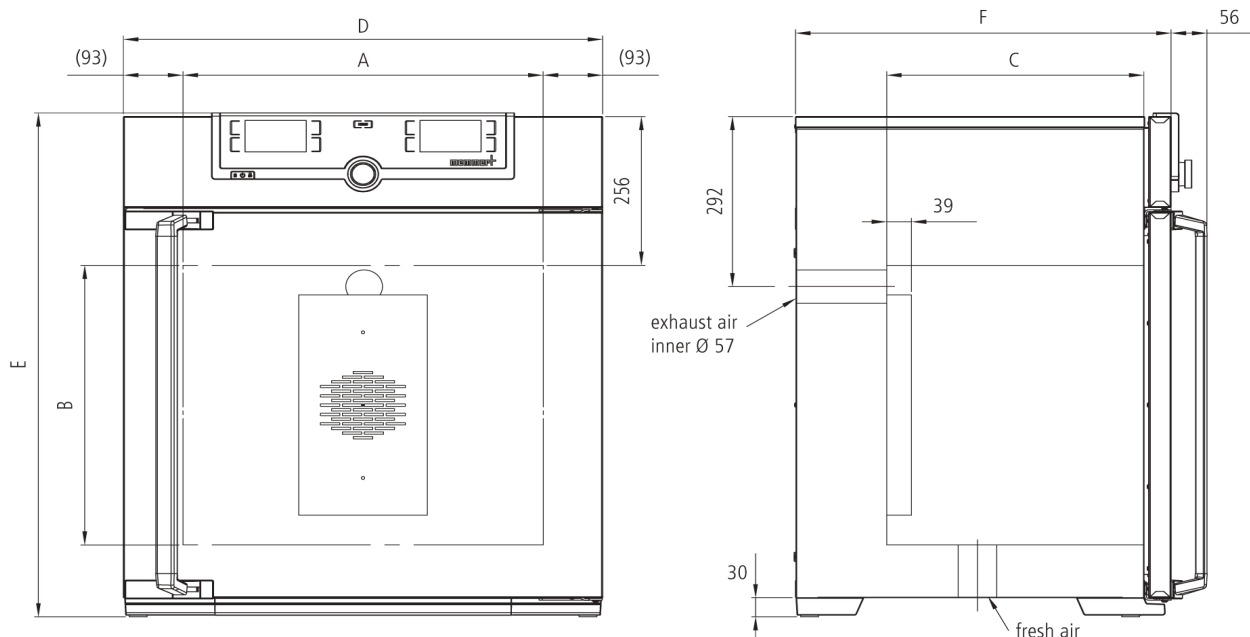

Temperature

Set temperature range in °C min. 5°C above ambient up to +300°C

Temperature 1 Pt100 sensor DIN class A in 4-wire-circuit

Control technology

Language setting German, English, Spanish, French, Polish, Czech, Hungarian

ControlCOCKPIT SingleDISPLAY. Adaptive multifunctional digital PID-microprocessor controller with high-definition TFT-colour display

Timer Digital backwards counter with target time setting, adjustable from 1 minute to 99 days

Function SetpointWAIT the process time does not start until the set temperature is reached

Calibration three freely selectable temperature values

adjustable parameters temperature (Celsius or Fahrenheit), air flap position, programme time, time zones, summertime/wintertime

Ventilation

Convection natural convection

Fresh air admixture adjustment of pre-heated fresh air admixture by air flap control in 10 % steps

Vent vent connection with restrictor flap

Communication

Documentation programme stored in case of power failure

Programming AtmoCONTROL software for reading out, managing and organising the data logger via Ethernet interface (temporary trial version can be downloaded). USB stick with AtmoCONTROL software available as accessory (on demand).

Safety

Temperature control adjustable electronic overtemperature monitor and mechanical temperature limiter TB, protection class 1 according to DIN 12880 to switch off the heating approx. 20°C above nominal temperature

Autodiagnostic system for fault analysis

Standard equipment

Door fully insulated stainless steel door with 2-point locking (compression door lock)

Internals 1 stainless steel grid(s), electropolished

Works calibration certificate Calibration at +160°C

Stainless steel interior

Interior	easy-to-clean interior,made of stainless steel, reinforced by deep drawn ribbing with integrated and protected large-area heating on four sides
Volume	32 l
Dimensions	$w_{(A)} \times h_{(B)} \times d_{(C)}$: 400 x 320 x 250 mm
Max. number of internals	3
Max. loading of chamber	60 kg
Max. loading per internal	20 kg

Textured stainless steel casing

Dimensions	$w_{(D)} \times h_{(E)} \times d_{(F)}$: 585 x 704 x 434 mm
Housing	rear zinc-plated steel

Electrical data

Voltage	230 V, 50/60 Hz
Electrical load	approx. 1600 W
Voltage	115 V, 50/60 Hz
Electrical load	approx. 1600 W

Ambient conditions

Set Up	The distance between the wall and the rear of the appliance must be at least 15 cm. The clearance from the ceiling must not be less than 20 cm and the side clearance from walls or nearby appliances must not be less than 5 cm.
Altitude of installation	max. 2,000 m above sea level
Ambient temperature	+5 °C to +40 °C
Humidity rh	max. 80 %, non-condensing
Overvoltage category	II
Pollution degree	2

Packing/shipping data

Transport information	The appliances must be transported upright
Customs tariff number	8419 8998
Country of origin	Federal Republic of Germany
WEEE-Reg.-No.	DE 66812464
Dimensions approx incl. carton	w x h x d: 660 x 890 x 650 mm
Net weight	approx. 45 kg
Gross weight carton	approx. 61 kg

Standard units are safety-approved and bear the test marks





WolfLabs

Pricing on any accessories shown can be found by keying the part number into the search box on our website.

The specifications listed in this brochure are subject to change by the manufacturer and therefore cannot be guaranteed to be correct. If there are aspects of the specification that must be guaranteed, please provide these to our sales team so that details can be confirmed.

www.wolflabs.co.uk

Tel : 01759 301142

Fax : 01759 301143

sales@wolflabs.co.uk

Please contact us if this literature doesn't answer all your questions.